



Proud member of IPMS USA <http://ipmsusa.org>

www.lisms-ipms.org

RED, WHITE & SPRUE

Volume 25 Number 1

★ LISMS Newsletter ★

January 2018

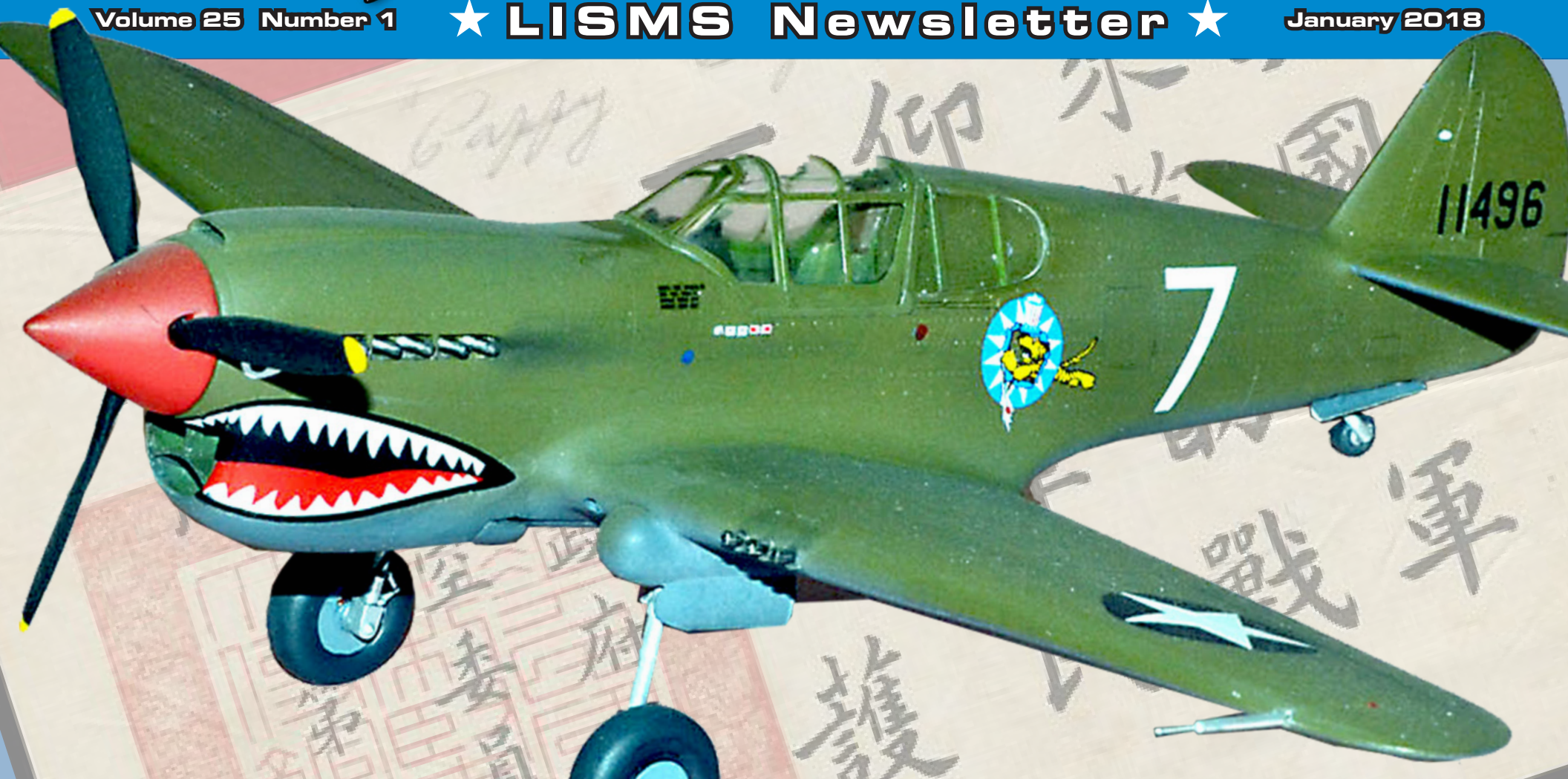

Book Review:
Jaguar D-Type Manual

In The Box Kit Review:
1/24 1955 Long Nose D-Type Jaguar

Photo Essay:
Aston Martin DB3

In The Box Kit Review:
1/48 Nakajima Ki-115 Tsurugi



Next meeting date:
Monday, January 15th
7:30 pm to 10 pm

Levittown Public Library
1 Bluegrass Lane, Levittown, NY

Executive Board

President: **Robert DeMaio**
631 707-3442
taurleo@optonline.net

1st Vice President: **Fred Seitz**
631 581-1990
seitzfjs3@gmail.com

2nd Vice President: **Tim Kelly**
516-621-0184
timothykly@aol.com

Corresponding Secretary: **Fred Seitz**
631 581-1990
seitzfjs3@gmail.com

Secretary: **Doug Tantillo**
516-541-7576
dtantill@optonline.net

Editor: **Steve Muth**
516 671-9456
sgmuth@optonline.net

Graphic Design: **Al Zygier**
917-832-7054
azygier@icloud.com

Cover Model: P-40 by Steve Muth
Cover Photo: by Steve Muth

In The Pilot Seat



Another new year started and each resolution I up my building number to top last year's number. I just finished a 1/32 scale aircraft and now starting a 1/35 scale armor kit. Each year makes me wonder how many models I will build this year of the 900 in storage waiting to build. I have a lineup of about nine in thought this year. Hmmm that leaves 891 still stored. I hear science is getting closer to making human clones, but will my clone be interested in model building? How many clones will I need to build my stash? How expensive will it be to have multiple clones? This is getting too confusing and think I'll just try to build faster, much faster.

Our newsletter designer thought it would be easier and nicer to produce it in landscape format. So we will give it a try starting with this January 2018 issue. Many new monitors sold over the past years have been letter size and landscape format should fit nicely. We'll see. If anyone has issues with this, let's hear from you.

As I type this up two weeks from our meeting, I am also working on the club questionnaire I said I'd do. Some questions will be a simple Yes/No, some check boxes, and a few fill in lines.

This next meeting is Monday January 15th, and YES the library is open. They stay open because they like us so much, hahaha, unless there is another storm we haven't heard about that may close the library. I will

have a few model kits, decals, and books tagged for sale. Money will go to the club treasury. Bring in any finished or models in progress to put on the tables. We like to see and share what we're doing. Be kind and welcome our new members to the club. Help answer any questions they ask about techniques. They are here to learn how to build better models.

Build for our **Noreastcon** show April 28th and 29th! Points are counted for each Region One chapter and the winning chapter is awarded the Regional Cup until the next **Noreastcon** in 2019. Our chapter name gets permanently engraved on it. How the points work: a first place winner gets three points, second place gets two points, third place gets one point, and any special place award gets four points. We have four months to build and that should be plenty of time. It's winter, no cutting lawns, or outdoor work! Put the indoor work on hold till May 1st! By the way, strong rumblings have it that NENY, Albany guys, are hosting next year's Noreastcon. I heard they found a hotel to host a two day show. I like road trips, especially when we don't have to do the work.

I sure hope we all have a healthy and safe new year ahead.

Keep our hobby alive and well!



Haynes Owner's Workshop Manual

Jaguar D-Type 1954 onwards (all models), by Chas Parker,
Published by Haynes Publishing
HB 2017, £25.00

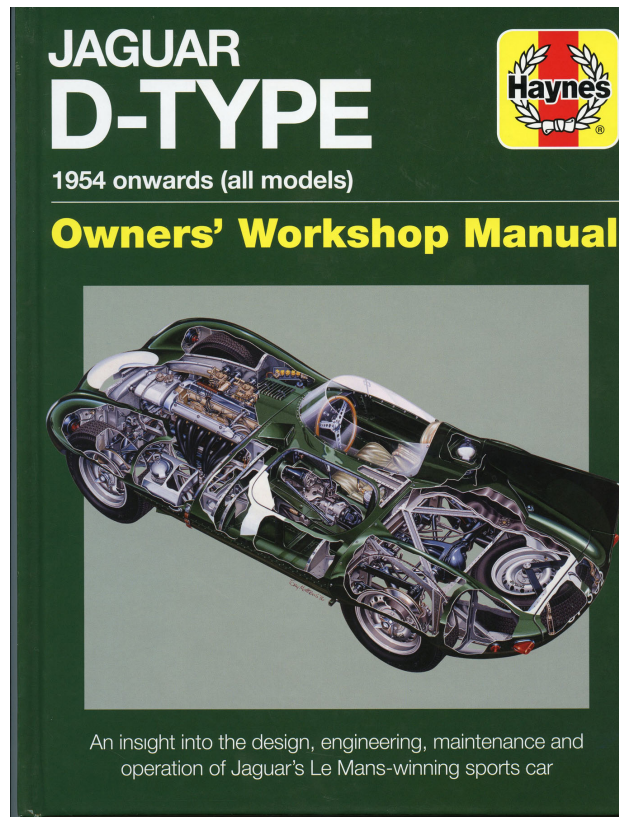

All you want to know about the D-Type but were afraid to ask! In 12 chapters.

There were 67 D-types produced, of which 20 were preproduction prototypes. Most of the cars were sold to private parties and were of the short nose variant while the works cars were the long nose configuration. All 20 factory cars are discussed individually while only 6 noteworthy private cars are mentioned. All unsold production cars were converted to XKSS specifications, suitable for the road.

Chapter 1 - Introduction (1Page) - A background statement by the author.

Chapter 2 - The D-Type Story - discusses the genesis of the D-Type from the XK-120, C-Type, and Light Alloy Car which ultimately led to the D-Type; first built in 1954. There are also short biographies/histories of noteworthy drivers.

Chapter 3 - The Anatomy - is a detailed discussion of the D-Type and has many detailed photos taken during the restoration of XKD-540 - an original specification car which was involved in an accident at the 2015 support race at Le Mans. It was restored by CKL Developments of Battle in East Sussex.

Chapter 4 - The Engineers View - The engineers at CKL give their views on the D-Type.

Chapter 5 - The Drivers Viewpoint - 9 drivers, varying from works drivers, Le Mans winners and private parties. Great stuff!

Chapter 6 - The Owners View - 3 owners wax eloquently on the joy of owning their D-Types.

Chapter 7 - Individual Chassis Histories - The histories of all 20 works cars plus 6 production cars are presented.

Chapter 8 - Restoration and Historic Racing - Follows the restoration of XKD-543 plus a brief dissertation on D-Type racing in general.

Chapter 9 - D-Type Replicas - A brief rundown on three replica manufacturers: Lynx, D-Type Replicas and Classic Jaguar Replicas.

The book has many color (203) and B&W (78) photos which are, in general, of large format, crisp and clear. With some single type books running in the \$100.00 plus range this book is a real bargain. Recommended to any one with the slightest interest in the D-Type Jaguar.

Chapter 10 - Appendix - 4 pages of D-Type Specifications.

Chapter 11 - Index - 3 pages.

Chapter 12 - A small window listing 4 publications and 2 web sites.



1/24 1955 Long Nose D-Type Jaguar

by Fisher Model & Pattern, Kit # 2401

The Fisher D-Type Jaguar is a resin multi-media curbside model in 1/24 scale. By curbside I mean it only has detail that you would see if it was parked at the curb – no engine, no running gear, no bottom detail, and no movable parts. That being said, it is an excellent kit that captures the voluptuous lines of the D-Type. It is the long nose version of 1955 with decals for the Le Mans winning #6 driven to victory by Mike Hawthorne and Ivor Bueb (with the single screen windshield). Jaguar D-Types went on to win Le Mans in 1956 and 1957.

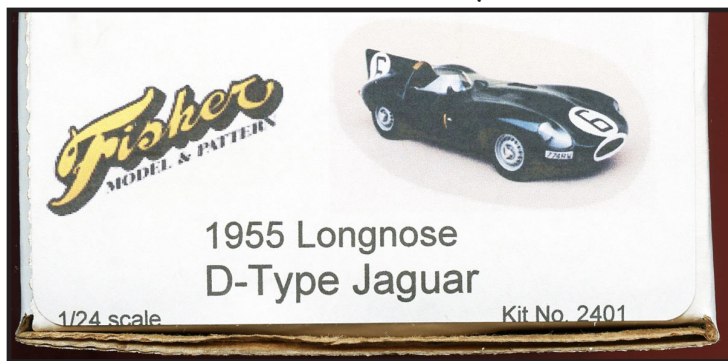

All parts but the body are packaged in ZIP lock bags in a very sturdy corrugated cardboard box. The 2 body parts are wrapped in tissue to keep things from rattling about getting scratched. The clear parts appear very clear and two duplicate vacuformed sheets are provided in case one gets ruined. The decal sheet has good registration and contains the #6 car number plus various instruments and such. I can't tell how opaque they are, but they look good. The tires have very nice tread without a mold line running down the center. Unfortunately, there is no sidewall detail on any of the tires (at least some had Dun-

lop Racing script on the sidewalls). There are two steering wheels – a four spoke and a three spoke.

The mold shapes have a satin finish and look very good; they will need to be either polished or primed and sanded. The edges of the body parts are rather rough and will require sanding and clean-up. A lot of the details are PE but it all seems to be there with except for of pedals in the foot-

well and side wall detail on the tires. These deficiencies can be corrected with parts from the excellent Revell Jaguar XK SS kit # 7205. From this you can get a pedal assembly (p/n 48), Tires, and to top it off – the wheels, which look better, having through holes (p/n 111). Of course, you will have to remove the chrome (I use brake fluid). I would build the Revell kit, but it doesn't have the fin and without the fin it just doesn't have the cache.

I like the kit but for the big bucks they should have put in the pedals, script on the tires and through holes on the wheels. But... in 1/24 I believe it is the only game in town unless you can find an old Lindberg kit but that is another story.

Recommended if you are into old fashioned modeling. It is not a shake and bake kit. 



Cont. on p5

In The Box Kit Review *by Steve Muth*

Cont. from p4



1/24 Scale 1955 Longnose D-Type Jaguar Assembly and Painting Instructions page one

Carefully inspect, trim and clean all the parts. You must clean all the resin parts with warm water and household bleach to remove the mold release film used in the casting process. Be very thorough in cleaning or your paint will not stick to the parts. An old soft toothbrush is very good for this work.

Begin by trimming and sanding the edges of the body, taking care to get the upper and lower parts to fit together well. It is a good idea to thin the edges of the wheel arches a bit to get closer to scale thickness before painting. Also be careful to clean out the air intake openings in the nose and pay attention to a good clean inner edge of the main intake as this will be very visible once it is painted white, one of the recognition features of car No.6.

You will need to paint the cockpit and install the dash before cementing the upper body to the lower half so careful prep and finishing of the interior surfaces first is a must. It is possible that the interior on the '55 cars was matte black, or medium RAF grey-green, I have been unable to get exact information on this to date. The foot-wells and rear bulkhead appear to have been natural metal.

Note that the Works car No.6 runs the long exhaust pipes under the tub while to build the Cunningham car No.9 you must use the side exhaust fairing and shorter pipes along with the 3 spoke steering wheel.

Colors:

Aluminum: Cockpit tub interior, wheels (painted)

Bright silver: Knock-offs, gear lever and hand-brake lever. Steering wheel centers should be left bare metal.

British Racing Green: Bodywork for Works cars.

White: Air intake Surround on No.6 Works car, and aft end of headrest fin. The Cunningham team entry car No.9 was white with 2 medium blue stripes.

Medium grey-green: Leather seat cushions and headrest cushion, top surfaces of center console of cockpit.

Matte black: insides of Headlamp buckets (these were a lighter color during scrutineering, and painted prior to the race). Dash face and radiator.

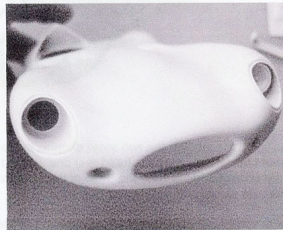
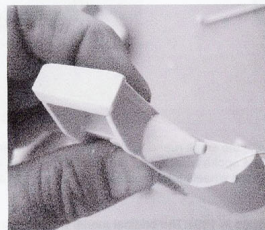
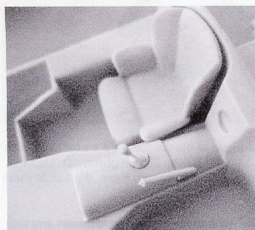

The seat, gear lever and hand-brake lever are located as above, left. Cement the radiator to the chassis front as in the center photo, note the beveled edge is to clear the bodywork. Open the headlamp mounting holes up until the lamps fit into them all the way back. The brake ducts and air intake need to be cleared of flash and made smooth.

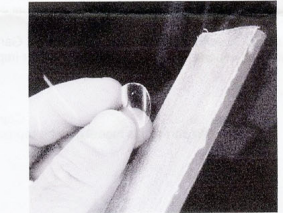

Above you can see the p/e instrument panel and resin dash in place. Place the decal instrument faces onto the resin dash and then overlay with the p/e panel. In the center photo you can see the small parts trimmed and ready to be painted bright silver. The tiny handles are for the bonnet and boot. The straps are leather, with bright silver end clips and buckles.

Before you paint the car, it's a good idea to cut out the clear headlamp cowls and windscreen. The easiest way to trim the cowls is to make a small sanding board with medium-coarse wet & dry paper on it and simply sand away the excess until the cowls fit into the recesses. Be sure to trim them just enough that they will still fit after painting the bodywork.

Carefully trim the windscreen to fit around the small mounting lip, and set it aside. Once you have the dash, gear lever and hand-brake in place, you can mate the top with the bottom and cement the two. Fill the seam and dress it smooth, you may need to squeeze the top a bit to get it to line up. Note the fit of the exhaust pipes under the tub.

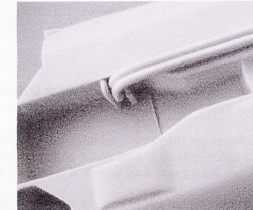
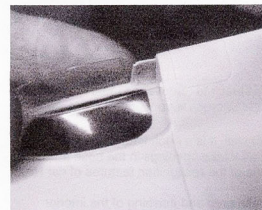

Paint the nose and tail-fin area white, and mask off before spraying the body BRG. This is much easier than trying to paint the white ID markings on the car after it is dark green. The photos below show the deal placement for the Works car and the Cunningham car. Note the mirror fairing on the Works car.

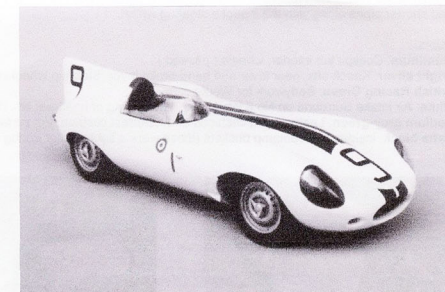

The tail lights mount over the two small dimples in the body, with the small round lights just forward of them. Use a piece of plastic rod for a steering column and mount the wheel then the head rest and windscreen. The 4 spoke wheel is for the Hawthorn / Bueb car, the 3 spoke for the Cunningham car. Use the small p/e screw heads around the base of the windscreen. Slip the wheels into the tires, and use a small amount of CA glue to secure them, then slide them onto the axle stubs, add decals and that's it.

This kit is somewhat modified from our original D-Type first issued in 1991. The original model was done as a gift for my father who was in ill health and I confess I was in a hurry to finish it before he passed away. Over the years I have wanted to revise the kit a bit to make it a bit better and so here we are.

The shape of the nose and head rest areas have been altered to have a more accurate look, and we have added the small p/e details, changed the wind-screen to an outside-mount as on the real car and done the tail lights as clear resin castings, separate from the body all of which allow the builder to create a more realistic model of this most beautiful of Jaguar race cars. It is a simple kit, but with a bit of effort a stunning model can be made.

Many thanks to John Johnson, Mike Quarterman, Gary McNutt, Norm Veber, Lloyd Asbury, Susan Simms and Susy Fisher for their hard work in the trenches and especially to my Dad, Ken Fisher for imparting his love of Jaguars and all things fast and beautiful to me.

Copyright 2009 All Rights Reserved, Paul M. Fisher
No part of this model may be reproduced by any means digital or mechanical without permission from the maker.

Made by Hand in the USA by:

Fisher Model & Pattern
5290 Buckboard Lane, Paradise, CA 95969 USA tel: 530-879-9900 e-mail:fisher@fishermodels.com
www.fishermodels.com

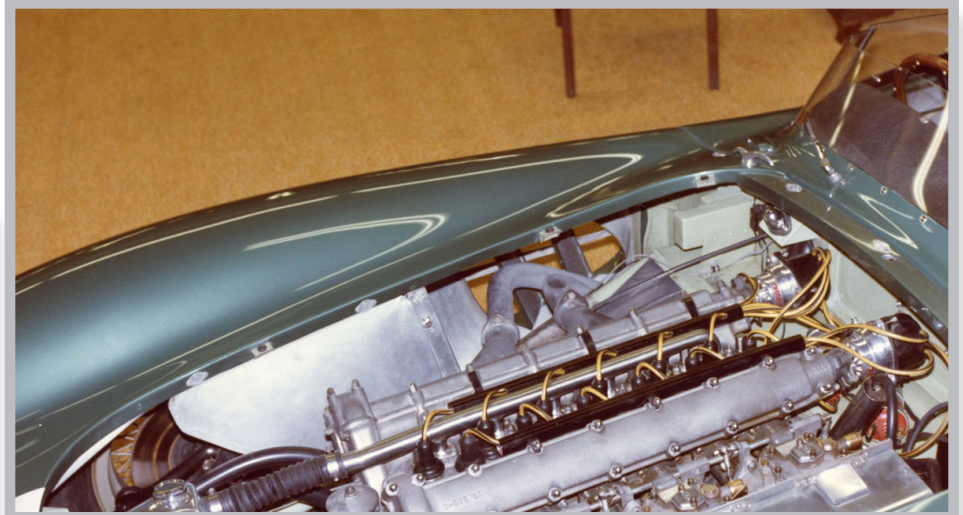

Photo Essay: Aston Martin DB3 Race Car *by Steve Muth*

These photographs of Aston Martin DB3 were taken in March of 1982 in the Concourse D'Elegance at the New York Annual Auto Show. Don't know who or what won. That info is lost in the mists of time.



Left front with engine bay.



Engine bay right side.

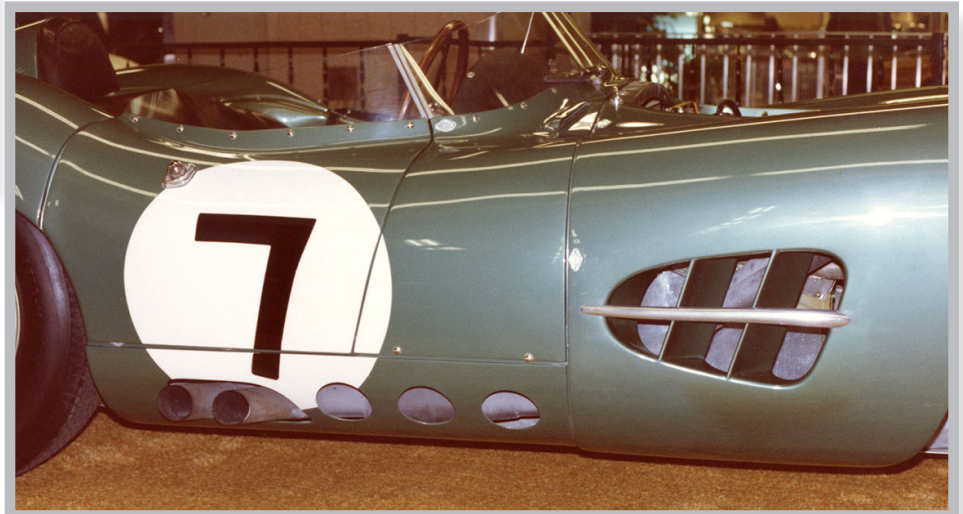

Right side mid section.

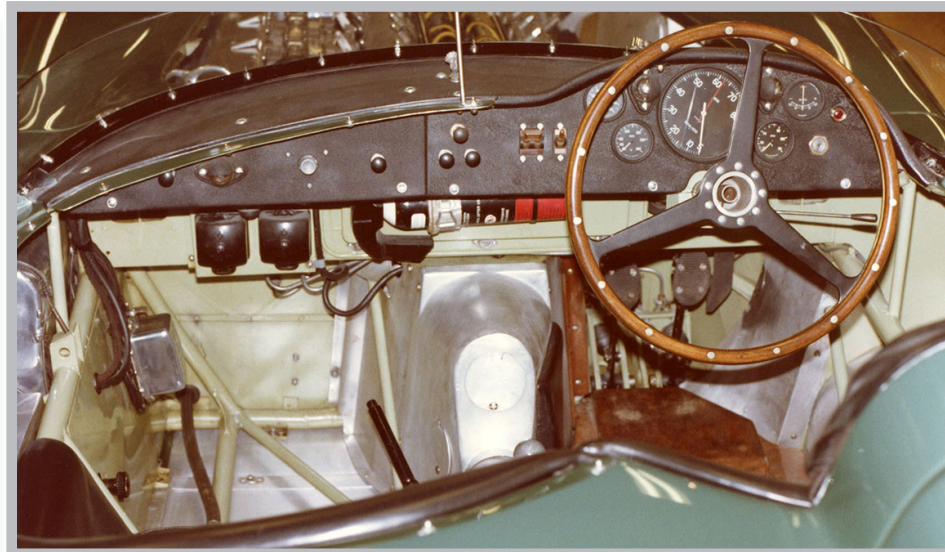

Photo Essay: Aston Martin DB3 Race Car *by Steve Muth*

Cont. from p6



Right rear details



Cockpit forward

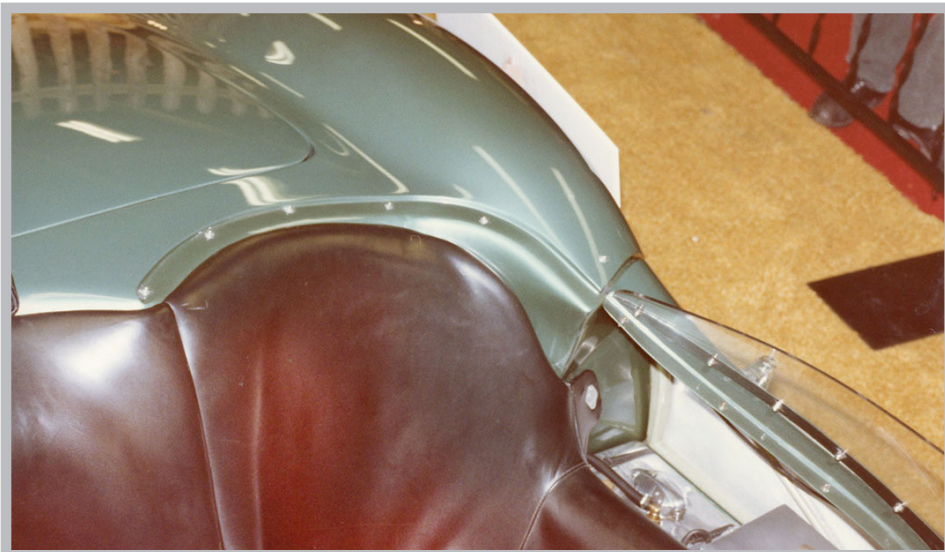

Cockpit left rear with seat



Cockpit left side

Cont. on p7

Photo Essay: Aston Martin DB3 Race Car *by Steve Muth*

Cont. from p7

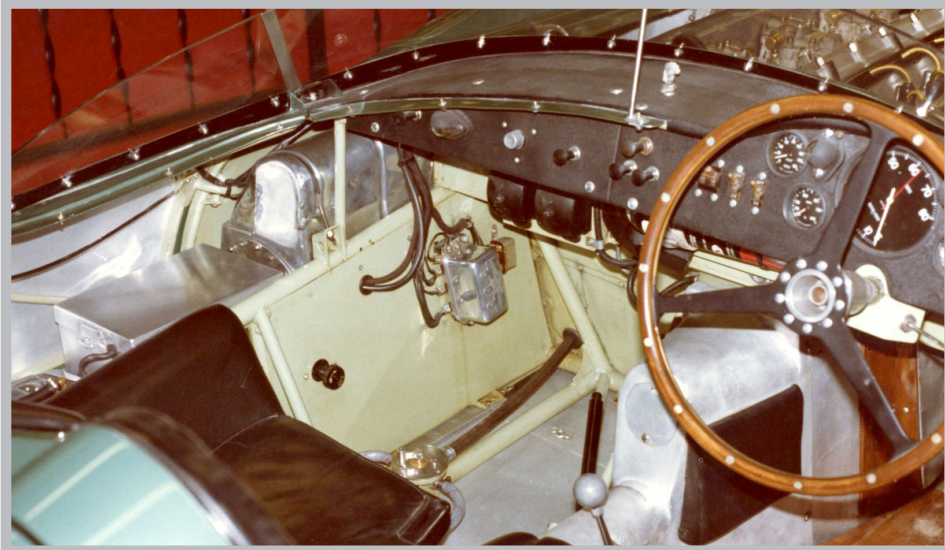

Cockpit left forward

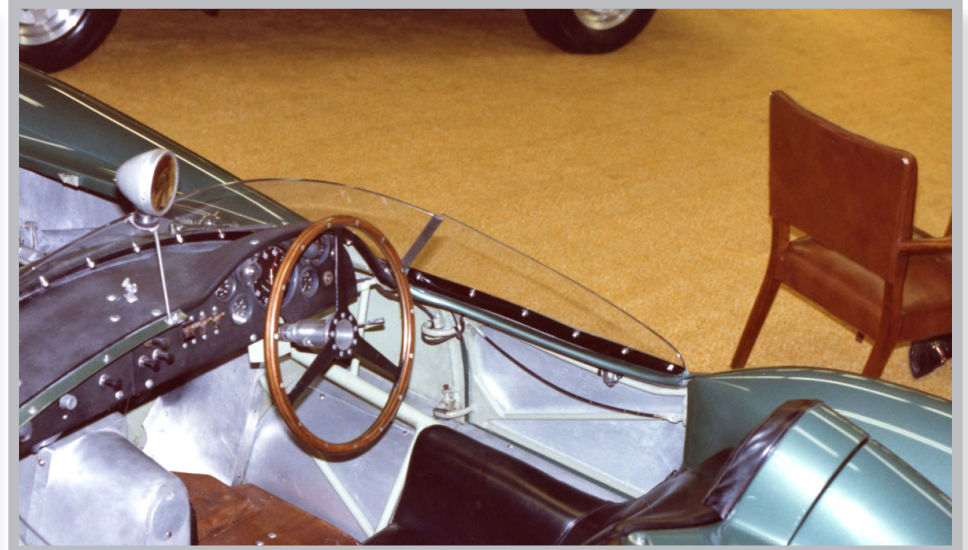

Cockpit right forward



1/48

eduard

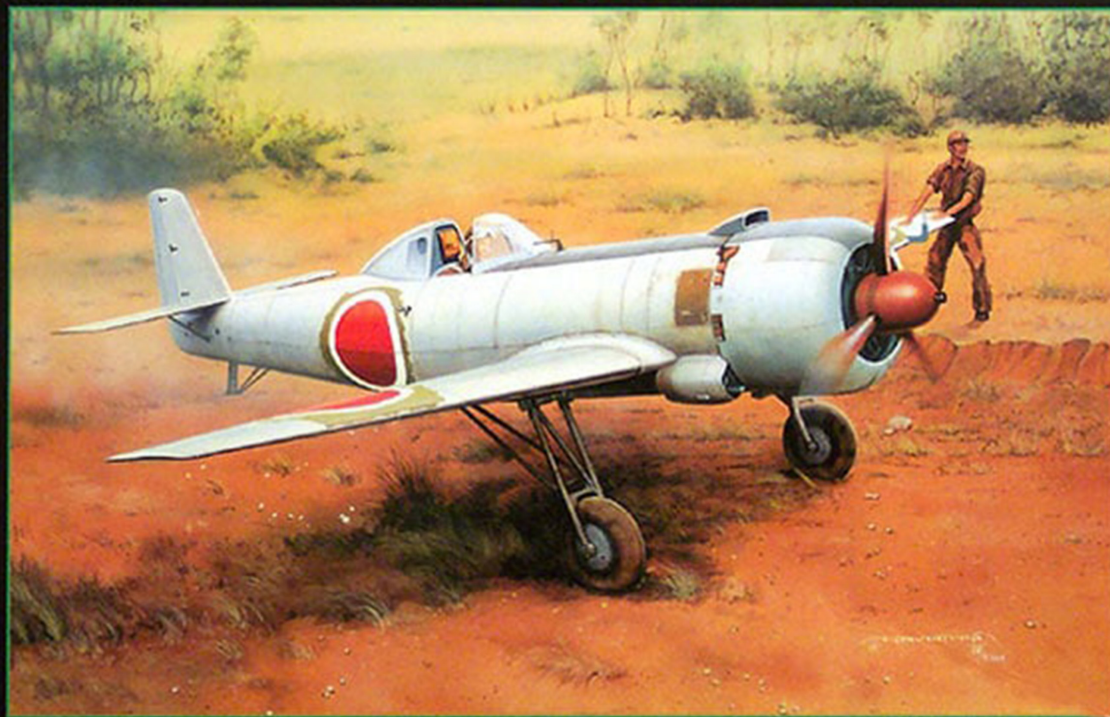

Ki-115 Tsurugi

1/48 Nakajima Ki-115 Tsurugi

Eduard # 8087, \$20.00 in 2006

The Ki-115 was a last-ditch attempt to field a low-cost suicide attack aircraft. Initiated in March of 1945, it first flew 3 months later. It had an offensive load of 250, 500, or 800kg bomb. To save weight and simplify manufacture, the landing gear was

not retractable but rather jettisoned after take-off. The rigid landing gear along with the limited cockpit visibility made ground handling difficult for the poorly trained pilots that were intended to fly them. In June 1945, at the end of testing, an improved landing gear and auxiliary flaps were fitted. In all 104 aircraft were manufactured but none were used due to the poor handling.

The kit is their first to utilize their new 3D CAD Molding technology and it shows. It comes in a very sturdy top opening corrugated cardboard box with attractive box art. Inside there are two

large resealable plastic bags for tan styrene sprues plus three smaller bags for the clear parts, PE fret, and canopy mask.

Loose in the box is a decal sheet for 3 different aircraft.

Registration is quite good and they appear to be opaque. The 12-page instruction sheet has 10 assembly steps and a color cross reference chart for *Tamiya, Humbrol, Revell* and *Testors* paints. There is also a parts tree diagram but there is no historical data provided. The moldings look very nice with good rivet and panel line detail. There were no sink marks and only a few ejection pin marks, and those only in inaccessible places in the fuselage and wings. There is one PE fret for the seat belts. The fuselage and wing parts had the only ejection pin marks, and they are in unobtrusive places. Parts for 250, 500 and 800 lb. are included.

This kit, I believe, marked the beginning of the high quality kits we have come to expect from Eduard.

All in all a nice kit not likely to be released by any other manufacturer. If someone can release a Ki-115 then it is probable that almost anything will be produced at sometime. Perchance an X-4?

Recommended if you can find one at a show.



Cont. on p10

Cont. from p9

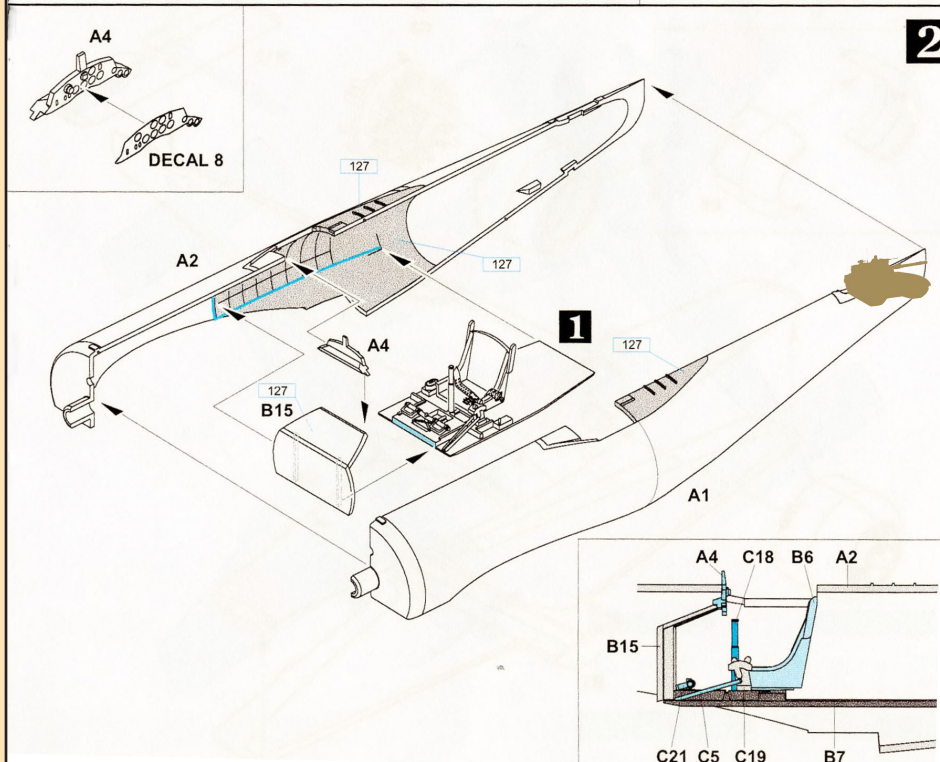
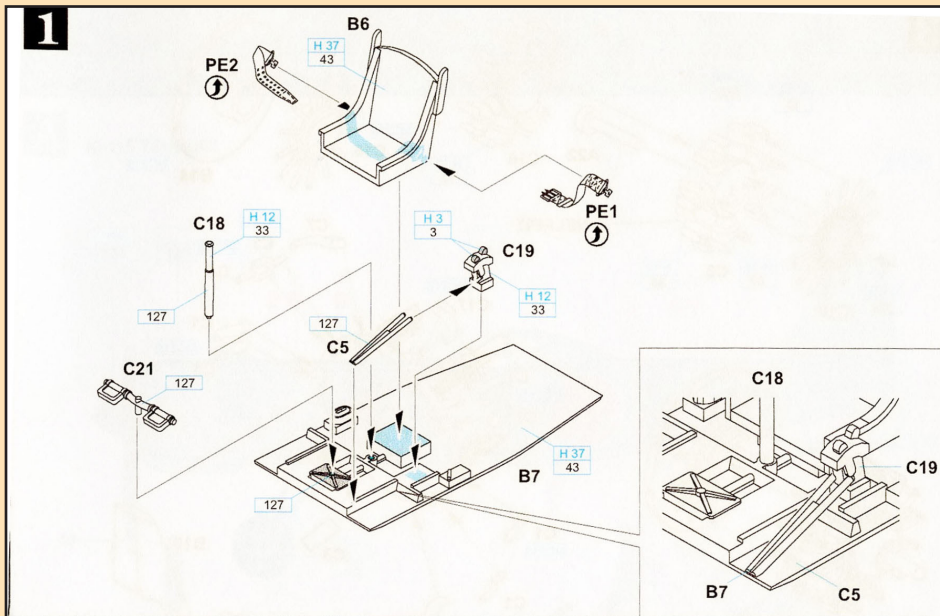

COLOURS		* BARVY	* FARBEN	* PEINTURE	* 色	
APPROXIMATE COLOR MATCH						
[H 3]	[3]	RED / ROT / ROUGE / ČERVENÁ	XF 20	19	31	1503
[H 12]	[33]	BLACK / SCHWARTZ / NOIR / ČERNÁ	XF 55	33	8	1749
[H 37]	[43]	WOOD BROWN / HOLZ / BOIS / DŘEVO	XF 55	110	88	2021
[H 77]		BLACK / SCHWARTZ / NOIR / ČERNÁ	XF 1	182	8	2040
[H 81]	[55]	KHAKI / KHAKI / KAKI / KHAKI		26	380	2099
[H 84]	[131]	BROWN / BRAUN / BRUN / HNĚDÁ	XF 10	98		
[H 319]	[128]	GREEN / GRÜN / VERT / ZELENÁ (NAKAJIMA)	XF 62	66	66	2115
[H 338]	[338]	GRAY / GRAU / GRIS / ŠEDÁ				1420
	[8]	SILVER / SILBER / ARGENT / STRĚBRNÁ				
	[126]	BLUE / BLAU / BLEU / ČERNO MODRÁ				
	[127]	GREEN / GRÜN / VERT / ZELENÁ (NAKAJIMA)		151		1716
[MC213]		STEEL / STAHL / ACIER / OCEL				1424
[MC218]		ALUMINIUM / ALUMINIUM / ALUMINIUM / HLÍNK	XF 56	56	89	1781
PARTS		* DÍLY	* TEILE	* PIÉCES	* 部品	

<A>

<C>

<D>

PE PHOTO ETCHED
DETAIL PARTS

Show Calendar Listing for 2018

See Bob DeMaio for details

Date/Day	Event & Location	Website
April 7 Sat	Mosquitocon 1 Pal Dr. Wayne, NJ	http://www.ipmsnj.org
April 27-28 Fri-Sat	2018 Noreastcon 47 Museum of American Armor Round Swamp Rd. Bethpage, NY	http://www.lisms-ipms.org
Sept. 17 Sun	Patcon 2018 Hudson Elks Lodge 959 99 Park Street, Hudson, MA, 01749	www.ipmspatriot.org
Sept. 21-22 Fri-Sat	Armorcon Crown Plaza Danbury, CT 06810	http://calendar.ipmsusa3.org/event/armorcon-1
Oct. 20 Sat	HVHMG 28 Elks Lodge 29 Overocker Road Poughkeepsie, NY	http://www.hvhmg.com
Nov. 11 Sun	Baycon 2018 Elks Ha 326 Farnum Pike Smithfield, RI	http://www.ipmsbaycolony.com

SUPPORT YOUR LOCAL HOBBY SHOP

The following Hobby Shops have supported us and are supporting us by paying for ad space here and on our web. Some have also donated raffle prizes for our meetings and our annual RePLIcon. We owe it to them to patronize their store even if we could buy the item for a slightly lower price mail order or on the web.

And don't forget to mention that you are a member of the LISMS and appreciate his or her support. Everybody likes a thank you.

Depending upon the size of your purchase, these shops have agreed to provide a possible 10% or more discount if you have our membership card.

Alsand's Toy Soldiers Plus

www.alsandtoyandsoldier.com

Alan & Sandy, Shop closed. On line orders only at this time.

Baseline Model Inc.

Eric, 250 Little East Neck Rd., West Babylon, NY 11704, (631) 376-0060, Military Model Specialist, old and new kits bought and sold. Retail and Mail Orders. Closed Mondays.

Get It On Paper

Gary Weickert, 185 Maple St., Islip, NY 11751, (631) 581-3897, open every Saturday noon to 5 PM. – Vintage Toys & Model Kits, Automobilia & auto Literature. Model kits wanted.

Men-At-Arms Hobbies

James Katona, 134 Middle Country Rd. (Rt. 25), Middle Island, NY (631) 924-0583– Excellent selection of lead miniatures-Historical and Fantasy. Plastic Models, War games & Modeling supplies. Books and Magazines.

The Marx-Man

John Stengel, (718) 418-9439 – We carry an array of toy soldiers in plastic and metal, from HO to 54 mm/60 mm. Die cast vehicles and Dragon action figures.

Trainville Hobby Depot

Weekend shows only: website: www.trainville.com and e-mail: info@trainville.com



IPMS /USA MEMBERSHIP FORM

Not an IPMS member? Need to renew your standing? You can clip out and mail in the form, download a fill-in copy from the [LISMS.org](http://www.lisms.org) web site or visit the IPMS store at <http://www.ipmsusa2.org/store> to submit your application on-line.

IPMS #

Name:

Address:

City/State: Zip:

E-Mail:

Phone:

Signature (required by P.O.)



Type of membership

- Adult 1 year \$30.00 Adult 2 years \$58.00 Adult 3 years \$86.00
- Junior (under 18 yrs) \$17.00
- Family, 1 yr \$35 (Adult + \$5, Ones set Journal) How Many Cards?
- Canada & Mexico: \$35 Other/Foreign: \$38 (Surface)

Checks must be drawn on a US Bank or International Money Order

PAYMENT OPTIONS:

Check Money Order Credit Card

Credit Card:  MasterCard  VISA  Discover

Card Number: Exp. Date:

Chapter Affiliation (if any):

If Recommended by an IPMS Member, Please List His/Her Name and Number:

Name: Number:

